

First astrophysical detection of the helium hydride ion (HeH^+)

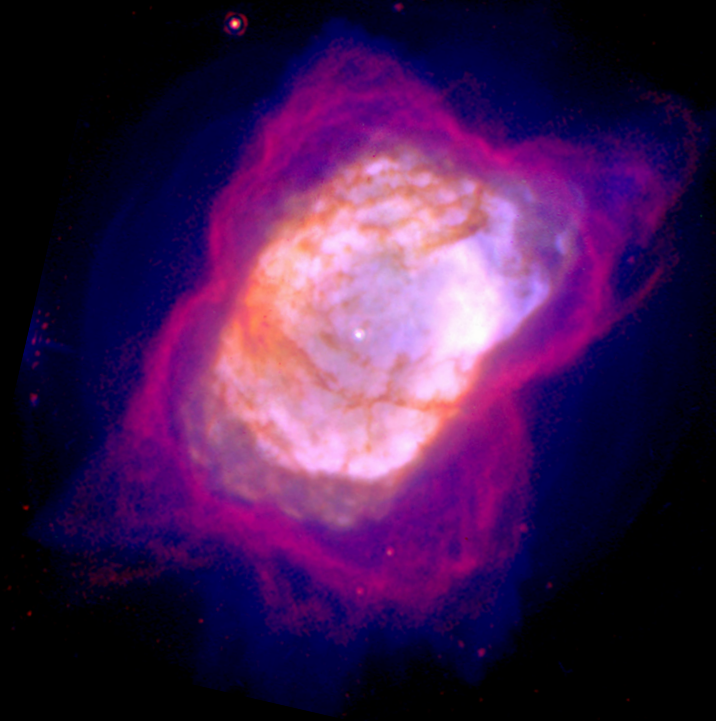
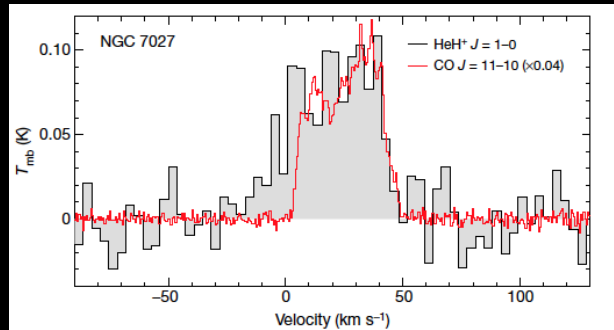

June 5, 2019

David Neufeld
Johns Hopkins University
... on behalf of ...

Güsten, Wiesemeyer, Neufeld, Menten, Graf, Jacobs, Klein,
Ricken, Risacher & Stutzki 2019, *Nature*, 568, 357 (arXiv:1904.09581)

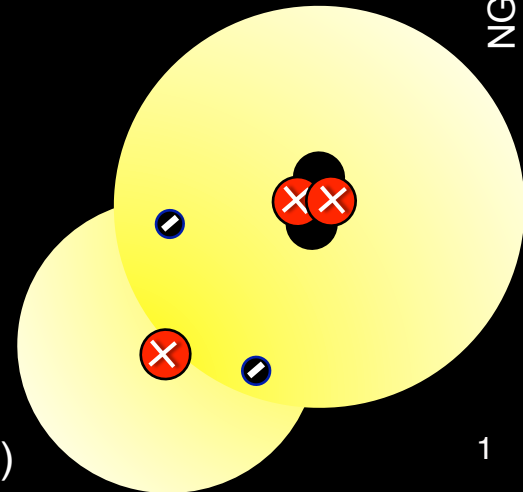

1. Introduction
2. First detection of HeH^+
3. Implications
4. Future prospects

HeH⁺ was first discovered in the lab in 1925
(Hogness and Lunn, Phys Rev. 26, 44)

Mass spectrometry of ions produced in a H₂/He discharge

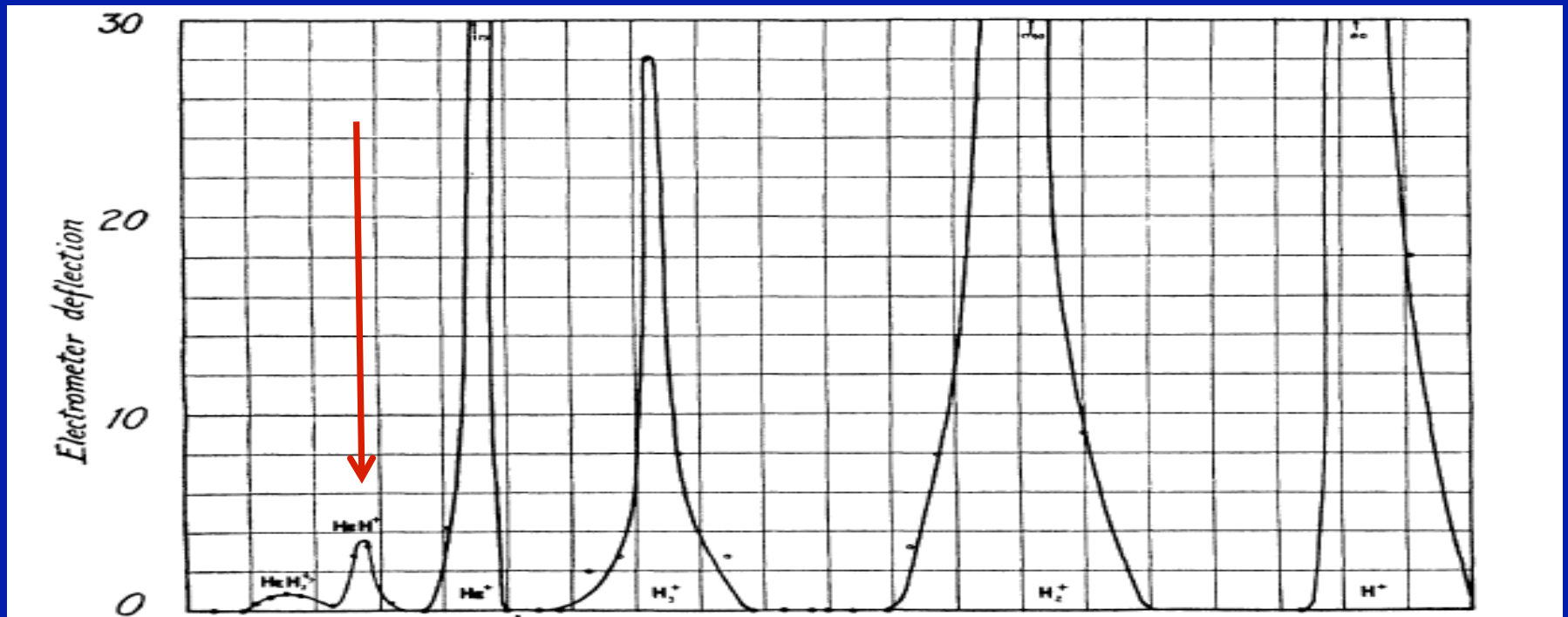

$e/m = \frac{1}{5} \quad \frac{1}{4} \quad \frac{1}{3} \quad \frac{1}{2} \quad 1$
 $\text{HeH}^+ \quad \text{He}^+ \quad \text{H}_3^+ \quad \text{H}_2^+ \quad \text{H}^+$

HeH⁺ sounds exotic, but is isoelectronic with H₂

H₂

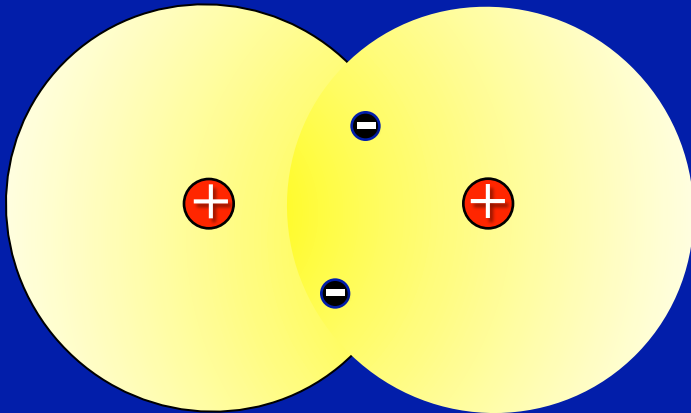

Rotational constant = 60.853 cm⁻¹
Dipole moment = 0

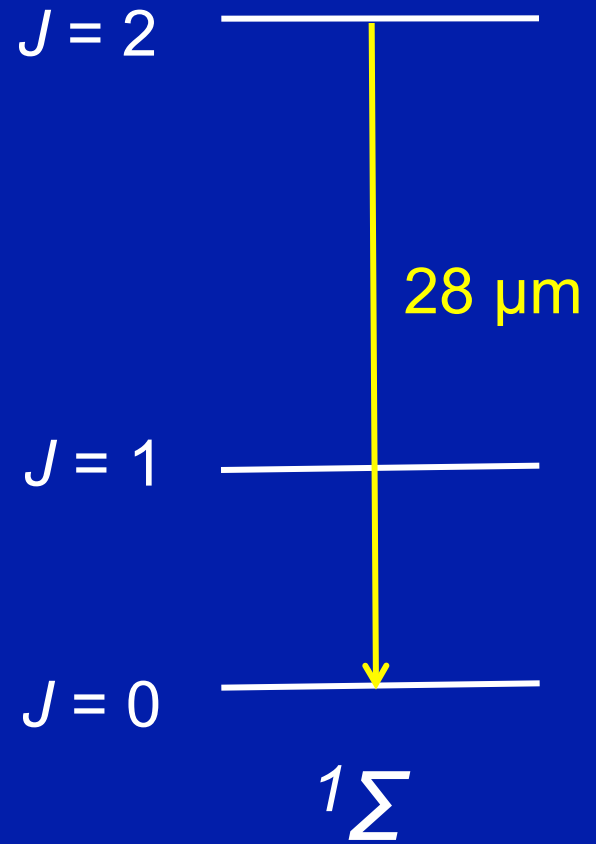

HeH⁺ sounds exotic, but is isoelectronic with H₂

H₂

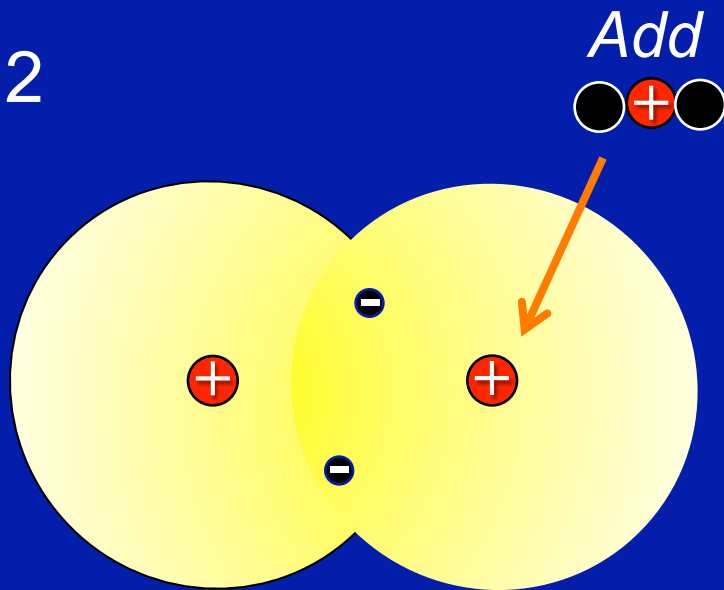

Rotational constant = 60.853 cm⁻¹
Dipole moment = 0

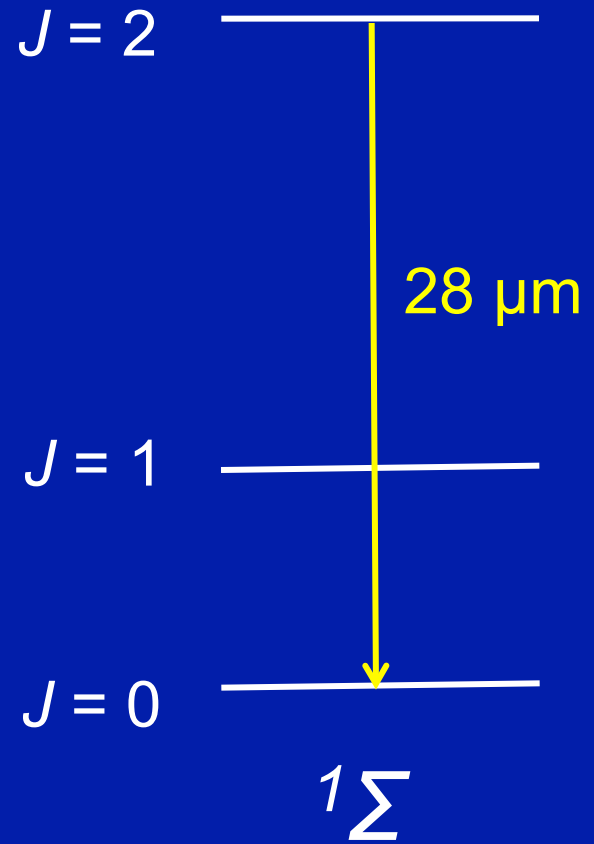

HeH⁺ sounds exotic, but is isoelectronic with H₂

HeH⁺

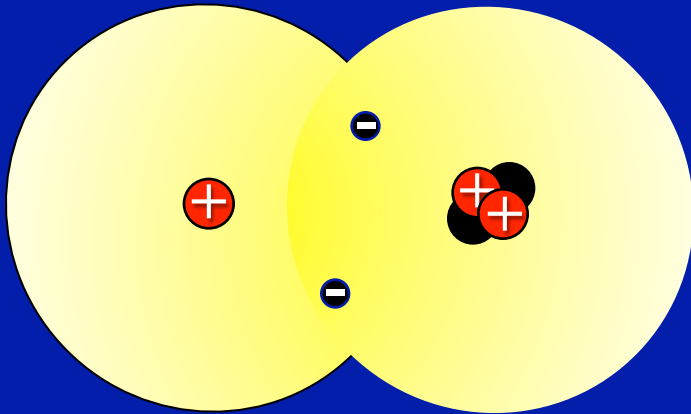

Rotational constant = 33.559 cm⁻¹
Dipole moment = 1.664 D

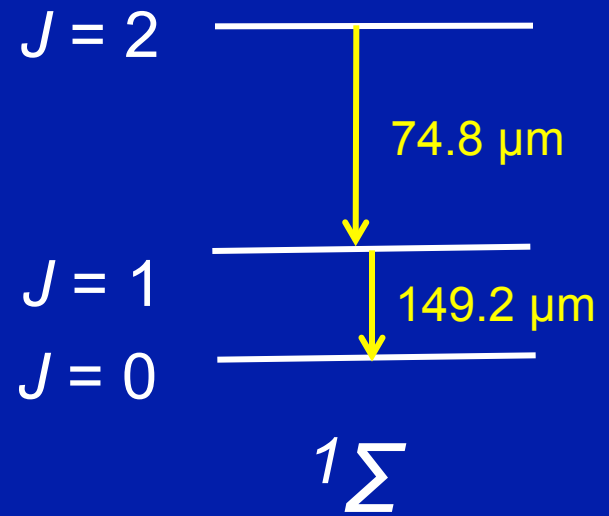

Other examples of isoelectronic molecular pairs/multiplets known in astrochemistry

Electrons		Closed-shell neutral	Isoelectronic ions
Total	Valence		
2	2	H ₂ H:H	HeH ⁺
14	10	CO :C:::O:	CF ⁺ , NO ⁺ (?), CN ⁻
18	8	HCl H:Cl:	ArH ⁺
14	10	HCN H:C:::N:	HCO ⁺ , N ₂ H ⁺
18	8	H ₂ S H:S:H	H ₂ Cl ⁺

$^3\text{HeT}^+$ is actually produced by radioactive decay of molecular tritium (T_2)

Volume 47A, number 4

PHYSICS LETTERS

8 April 1974

OBSERVATION OF VIBRATIONAL TRANSITIONS IN $(^3\text{He } ^3\text{H})^+$ AFTER β -DECAY IN THE TRITIUM MOLECULE

R. RAITZ Von FRENTZ, K. LUCHNER, H. MICKLITZ and V. WITTWER

Physik-Department, Technische Universität München, München, West Germany

Received 13 February 1974

We have observed an infrared emission band at $(4.69 \pm 0.03)\mu$ as a consequence of β -decay in molecular tritium [$^3\text{H}_2 \xrightarrow{\beta^-} (^3\text{He } ^3\text{H})^+$] at 25 K. This emission is due to β -recoil-induced vibrational excitation.

Tritium nuclei β -decay to ^3He with a half-life of 12.3 yr.

90 – 95% of decays of molecular tritium leave the product (helium hydride ion) in a bound state

Recoil \rightarrow vibrational excitation ($v=1$ produced in $\sim 20\%$ of decays)

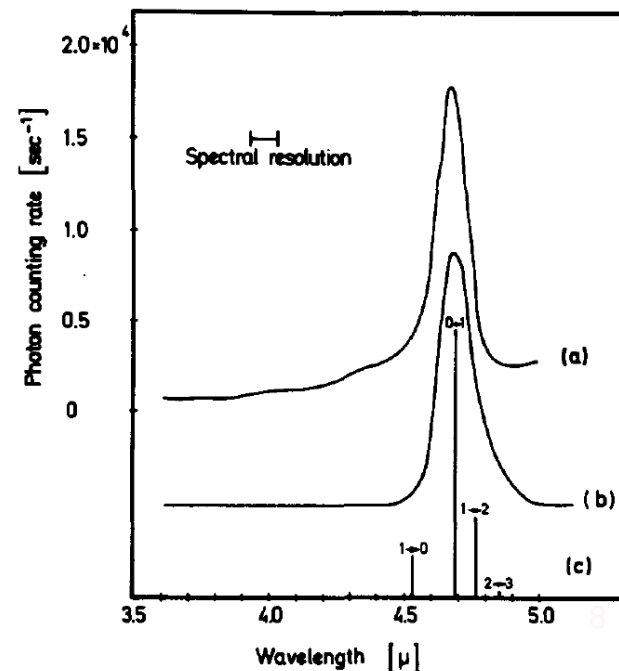

Although it is a stable closed shell molecule, HeH^+ is only weakly bound

Neutral	Proton affinity (kJ/mol)	Ion
He	178	HeH^+
Ne	201	NeH^+
H	258	H_2^+
H_2	424	H_3^+
O	485	O^+
CO	594	HCO^+

HeH^+ is extremely reactive, and will transfer a proton to ANY neutral atom or molecule

→ it can be considered the strongest acid

Late-1970's: recognition of HeH^+ as a potentially-observable astrophysical molecule

Black (1978) model for HeH^+ in a planetary nebula

This followed the suggestion (Dabrowski & Herzberg 1977) that HeH^+ vibrational emissions might be responsible for mid-IR features at 3.28 and $3.4\mu\text{m}$ observed (at low spectral resolution) from the young PN NGC 7027. (This turned out to be incorrect: those features are due to PAHs.)

Additional theoretical studies were conducted by Flower & Roueff '79, by Roberge & Dalgarno '82, and by Cecchi-Pestellini & Dalgarno '93

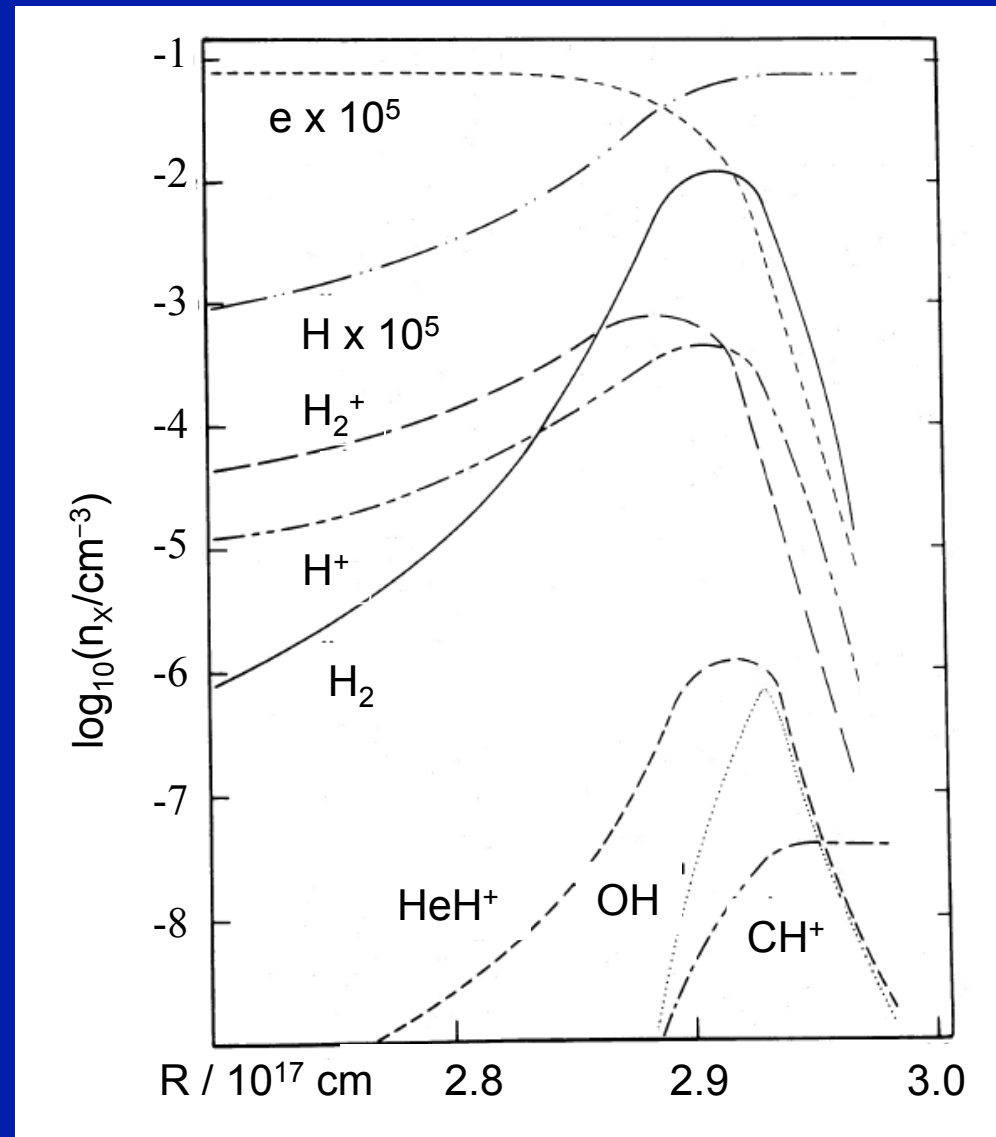

1990's onward: HeH⁺ recognized as the first molecule to form in the Early Universe

HeH⁺ is one of a very few molecules that can form in material of primordial elemental composition

Predicted to form via a slow radiative association reaction



Pathway to H₂ formation:



Galli & Palla 2013, ARAA

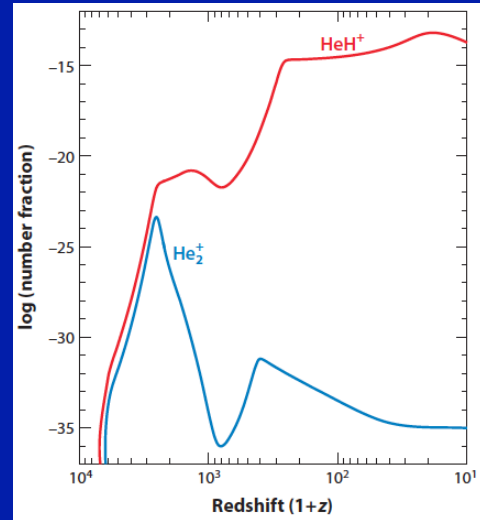

(note different ranges plotted on horizontal axes)

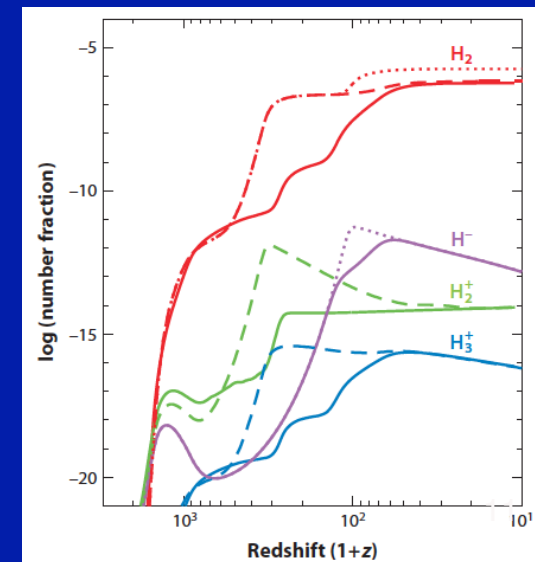
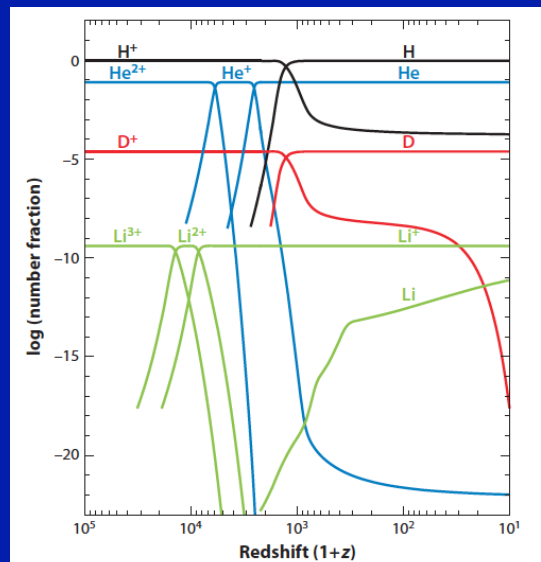

1988 onward: unsuccessful attempts to detect HeH⁺ toward NGC 7027

From the ground:

Moorhead et al. (1988): upper limit on $\nu = 1 - 0$ R(0) at 3.364 μm

Dinerstein & Geballe: upper limit on $\nu = 1 - 0$ P(2) at 3.609 μm

From space:

Liu et al. (1997): upper limit on HeH⁺ $J = 1 - 0$ at 149.1 μm with ISO. Here, the spectral resolution was insufficient to distinguish HeH⁺ $J = 1 - 0$ from a nearby CH lambda doublet

Liu, Barlow, Dalgarno et al. 1997, MNRAS (ISO/LWS grating spectrum)

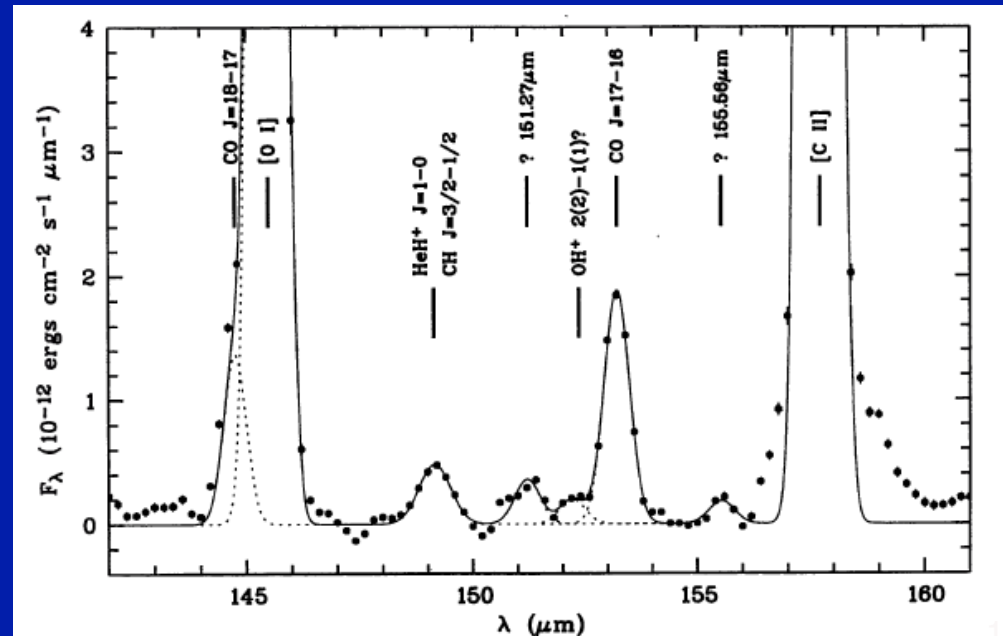

1. Introduction
2. First detection of HeH^+
3. Implications
4. Future prospects

First detection of HeH⁺

The GREAT heterodyne spectrometer on SOFIA provides the first access to the HeH⁺ $J = 1 - 0$ line at the necessary sensitivity and spectral resolution

The line frequency, 2010.184 GHz, lies above the range that was covered by *Herschel*/HIFI

Key advantage of developing terahertz technology hand-in-hand with the operation of the SOFIA observatory: rapid deployment of cutting edge technology

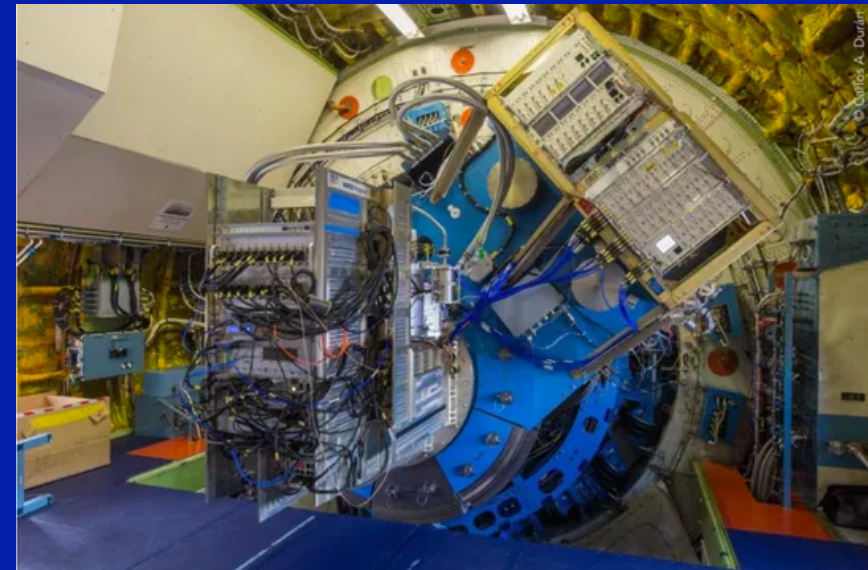

Observations of NGC 7027 were carried out on three flights in May 2016

NGC 7027 is a young planetary nebula with a very hot (190,000 K) central star

Beam size = 14.3" HPBW (diffraction limited), slightly larger than the source

Main-beam brightness temperature = 3.6 ± 0.7 K km/s

Flux = $1.6 \pm 0.3 \times 10^{-13}$ erg cm⁻² s⁻¹

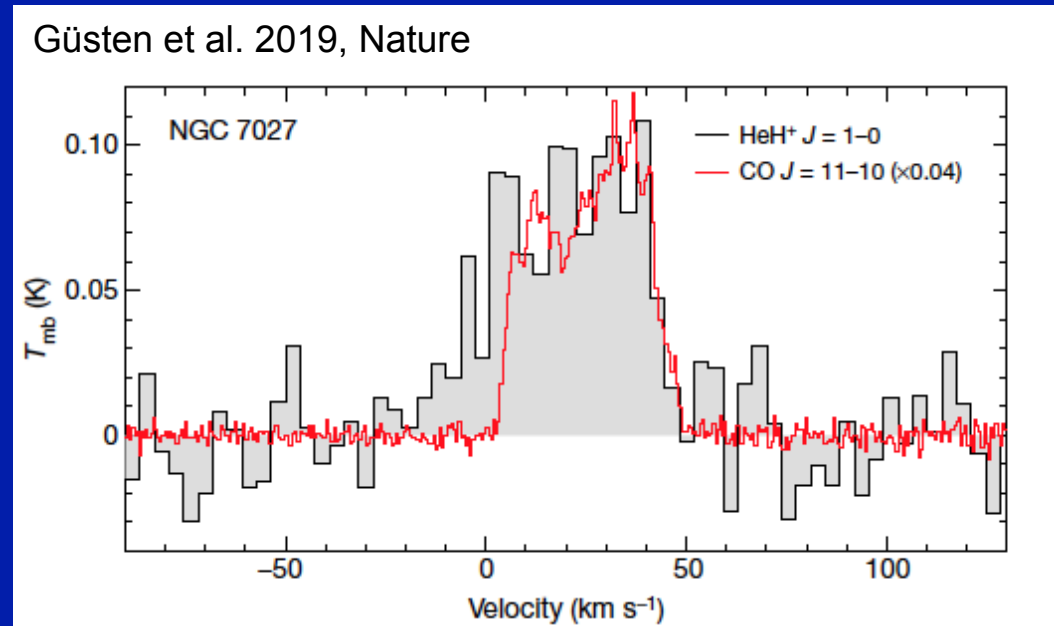

Clear detection of the HeH⁺ $J = 1 - 0$ transition (histogram), overlaid on CO $J = 11 - 10$ (red)

At the spectral resolving power of GREAT, the line is easily separated from the CH doublet

Güsten et al. 2019, Nature

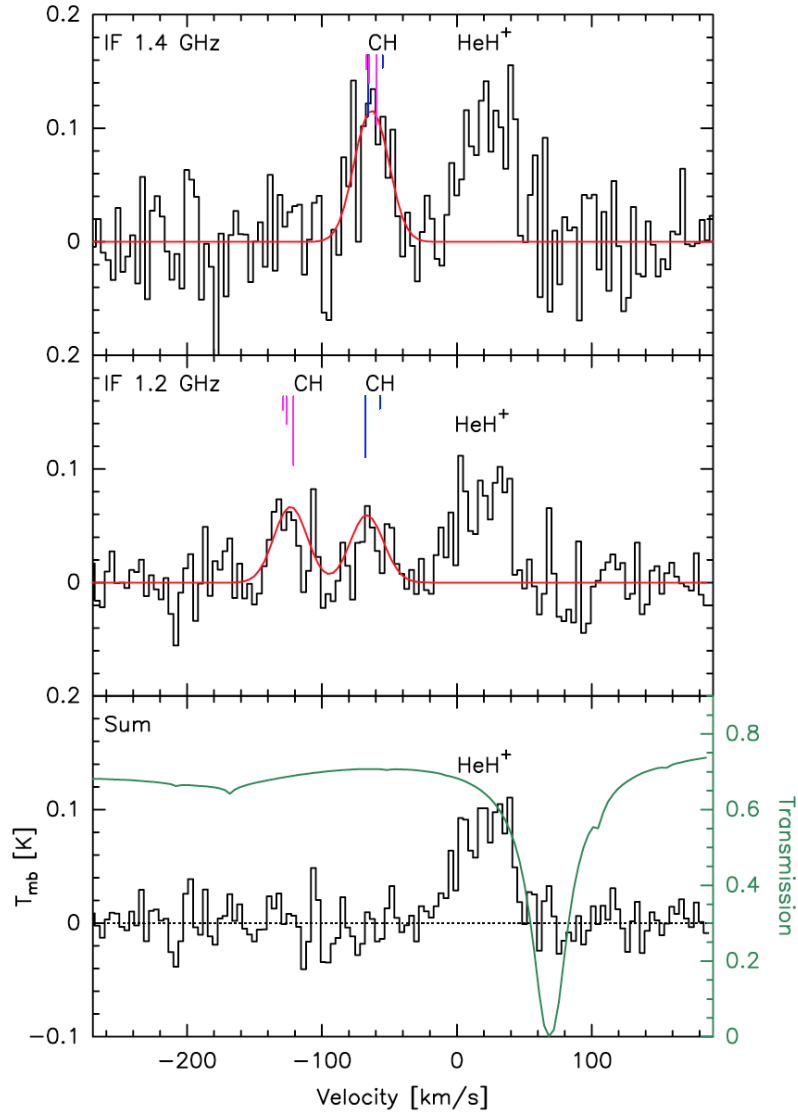

Double sideband receiver

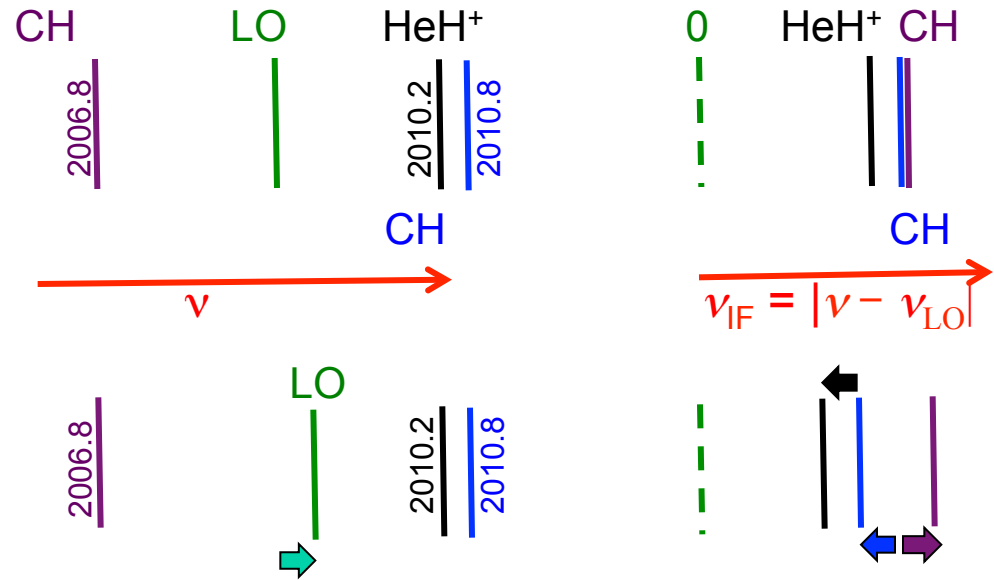

Transition $^2\Pi_J$	hfs F ^P	ν_{hfs} [GHz]	λ_{hfs} [μ m]	relative line strength	line intensity [K km/s]
CH $^2\Pi_{3/2} \rightarrow ^2\Pi_{1/2}$	$1^- \rightarrow 1^+$	2006.7488646	149.392	0.2	1.5 (0.3)
	$1^- \rightarrow 0^+$	2006.7625778	149.391	0.4	
	$2^- \rightarrow 1^+$	2006.7990641	149.308	1.0	
	$1^+ \rightarrow 1^-$	2010.7385887	149.096	0.2	1.5 (0.3)
	$1^+ \rightarrow 0^-$	2010.8104600	149.090	0.4	
	$2^+ \rightarrow 1^-$	2010.8119200	149.090	1.0	
HeH ⁺ (J=1-0)		2010.1838730	149.137	--	3.6 (0.7)

Is a “single-line” detection secure? Yes.

When rich molecular sources are observed with high sensitivity at millimeter wavelengths, the density of spectral lines can be very high. Thus, multiple lines must be detected to secure a molecular identification.

But here the density of U-lines of comparable strength in this wavelength region is ~ 0.16 per micron (3 in 19 μm bandpass)

Probability of “interloper” within 10 km/s ($0.005 \mu\text{m}$) of the HeH^+ Rest frequency is

$$\sim 0.16 \times 0.005 = 8 \times 10^{-4}$$

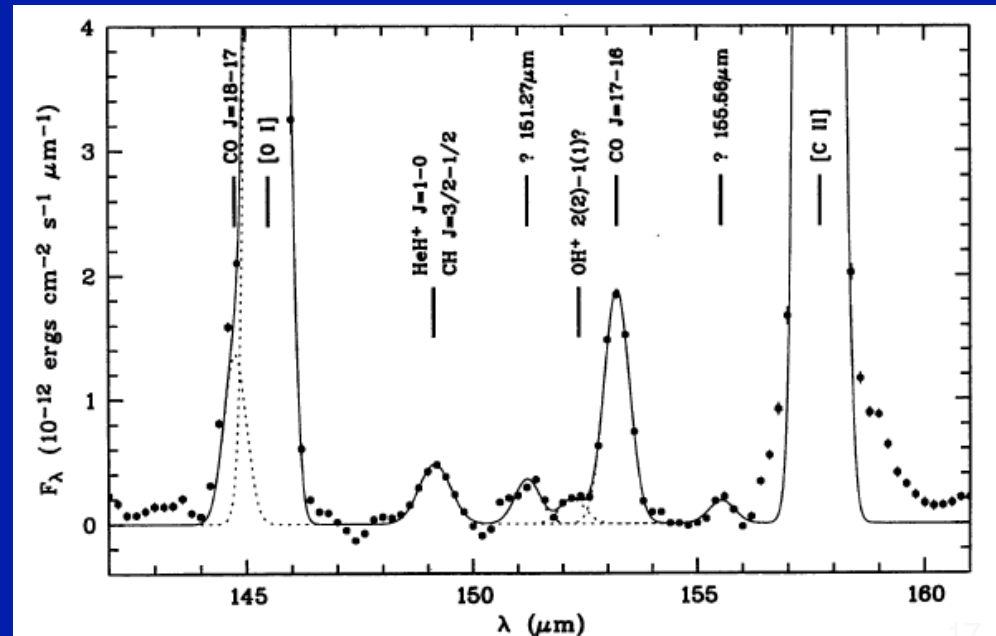

1. Introduction
2. First detection of HeH^+
3. Implications
4. Future prospects

We have revisited the predictions for HeH⁺ in a planetary nebula

We used the CLOUDY photoionization model (Ferland et al. 2013) to predict the radial dependence of the temperature and abundances of H, H⁺, He, He⁺, and e.

Adopted distance = 980 pc

Stellar effective temperature = 1.9×10^5 K

Stellar luminosity = $1 \times 10^4 L_{\odot}$

Average angular radius of ionized gas:
3.1" (inner), 4.6" (outer)

Assumed

constant pressure (set to match radius)
spherical symmetry

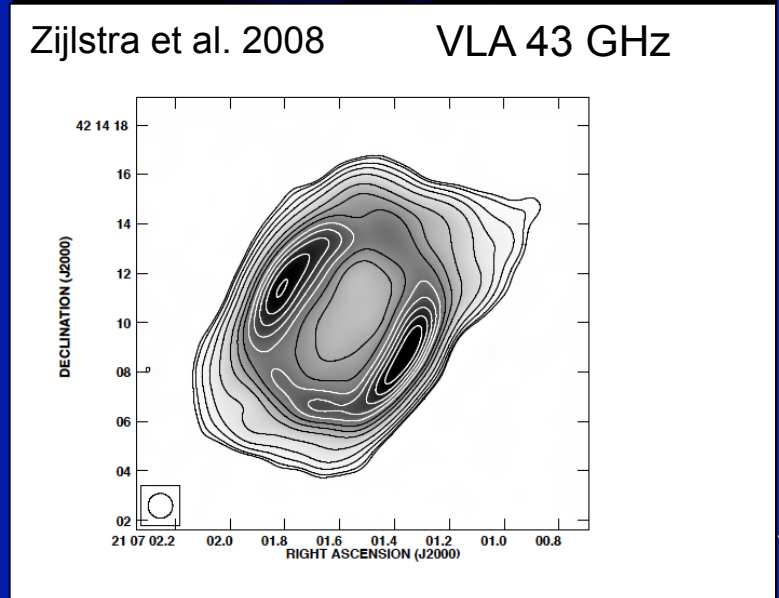
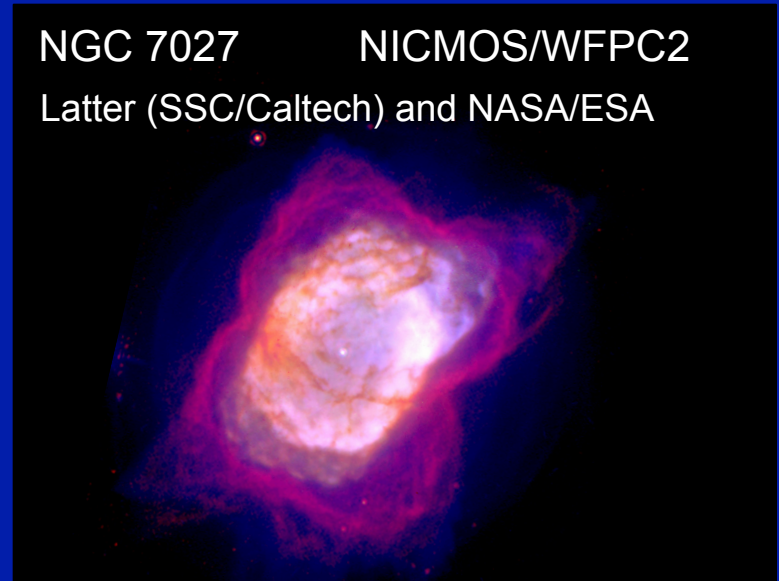

We have revisited the predictions for HeH⁺ in a planetary nebula

CHEMISTRY

Main formation mechanism

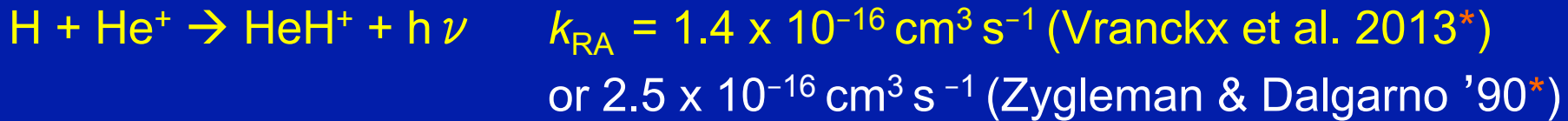

Minor formation pathway

**after factor 4 correction for “approach factor”*



Main destruction mechanisms



***after correction by Novotny 2019*

Minor destruction mechanism



We have revisited the predictions for HeH⁺ in a planetary nebula

EXCITATION

Critical density above which collisional deexcitation of $J = 1$ dominates radiative decay is $\sim \text{few} \times 10^6 \text{ cm}^{-3}$, somewhat larger than n_e

The critical density is even higher for $J > 1$

→ almost every excitation from $J = 0$ to $J \geq 1$ yields a $J = 1 - 0$ photon

Effective rate coefficient

$$= \sum_{J \geq 1} q_{0J} = 2.8 \times 10^{-7} \text{ cm}^3 \text{ s}^{-1} \text{ (Curik \& Greene 2017)}$$
$$\text{or } 6.1 \times 10^{-7} \text{ cm}^3 \text{ s}^{-1} \text{ (Hamilton et al. 2016)}$$

Model predictions

Given our adopted values for the various rate coefficients, the model underpredicts the measured line intensity by a factor of four

This discrepancy may point to a larger radiative association rate (and/or collisional excitation rate) than what we adopted

Prediction: HeH⁺ lies in a thin shell, where He⁺ and H overlap

In contrast to the Early Universe case, it is produced by (the much more rapid) radiative association of He⁺ and H, not He and H⁺

Note: the He⁺ region is slightly larger than the H⁺ region. This is due to the frequency dependence of the photoelectric absorption cross-section, which means that UV radiation capable of ionizing He penetrates more deeply into the neutral zone than radiation capable of ionizing H.

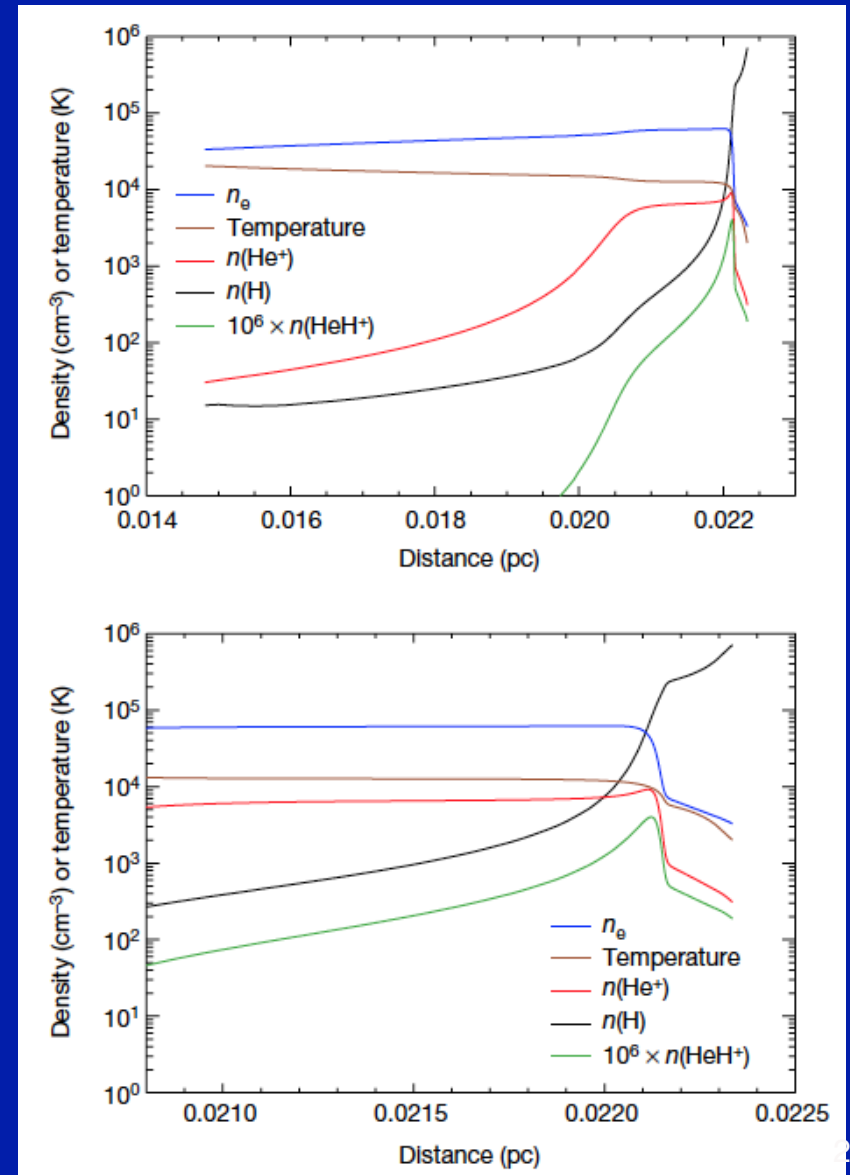

1. Introduction
2. First detection of HeH^+
3. Implications
4. Future prospects

Additional sources

I've conducted a parameter study to determine the dependence of the predicted line intensity on relevant astrophysical parameters: L , T_{eff} , n_{H}

Column density, $N(\text{HeH}^+)$, depends mainly on T_{eff}

Line strength is also roughly proportional to density below $n_{\text{H}} = \text{few} \times 10^5 \text{ cm}^{-3}$

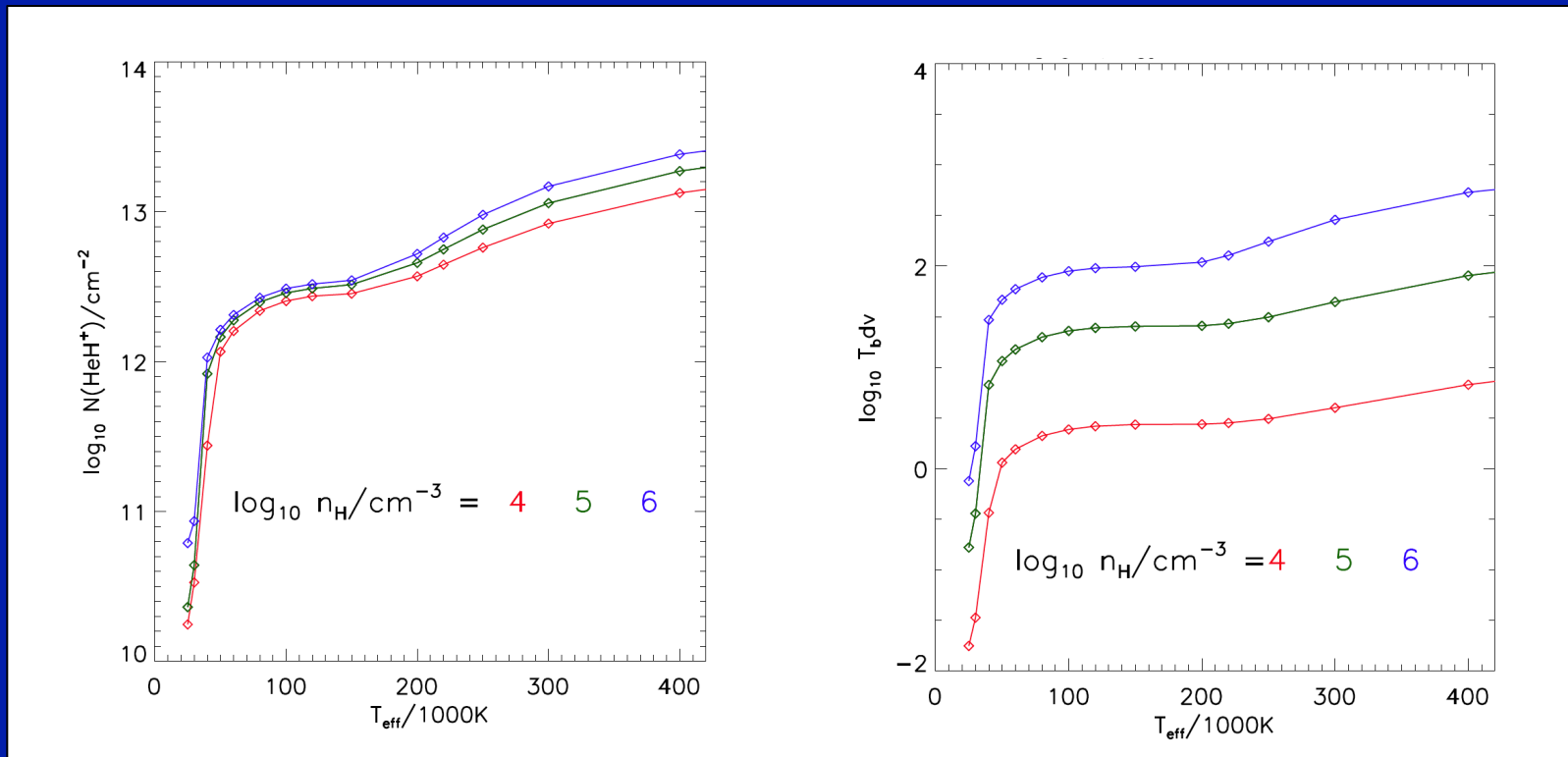

Additional sources

Promising targets

NGC 6537

“Red spider”

$T_{\text{eff}} \sim 150,000 - 250,000 \text{ K}$

(Matsuura et al. 2005)

$n_e \sim 1.6 \times 10^4 \text{ cm}^{-3}$

(Rowlands et al. 1994)



NGC 6302

“Butterfly”

$T_{\text{eff}} \sim 200,000 \text{ K}$

(Szyszka et al. 2009)

$n_e \sim 1.4 \times 10^4 \text{ cm}^{-3}$

(Rowlands et al. 1994)



Other transitions

Two other possibilities:

$J = 2 - 1$ pure rotational transition at $74.78 \mu\text{m}$

- Should be detectable with HIRMES (new SOFIA instrument to be commissioned in 2021)
- Could resolve uncertainty in excitation rates: two recent studies disagree about excitation rate to $J = 1$, but agree about rate to $J \geq 2$

$\nu = 1 - 0$ transitions in mid-IR

- Target R(0), P(2), and P(1) lines simultaneously with iSHELL on IRTF
- Director's discretionary time for NGC 7027 on July 12/13, and fall semester program submitted (which includes other sources)
- Should provide spatial information: test radial dependence prediction
- Could resolve uncertainty in excitation rates: two recent studies agree about rate to $\nu = 1$